



# DAMID 200 AL

Round enamelled winding wire of aluminium, heat resistant, class 200

## Product name:

Damid 200 AL

## Specifications:

IEC 60317-25

## UL approval:

Approved: Damid 200

UL-file no: E101843

## Class: 200

Temperature index  $\geq 200^{\circ}\text{C}$

Heat shock:  $\geq 220^{\circ}\text{C}$

## Conductor material:

EN 1715 - EN AW1370 [Al 99.7]

## Insulation:

Basecoat: THEIC-modified polyester or polyesterimide

Overcoat: Polyamide-imide

## Properties:

- High heat resistance
- Suitable in lightweight designs
- Very good resistance to transformer oils
- Very good resistance to typical solvent
- Freon resistant

## Field of application:

- Lightweight designs
- Electric motors
- Oil-cooled transformers
- Dry-insulated transformers
- Welding transformers

## Dimension range:

Damid 200 AL - Gr 1:  $1,50 \leq \varnothing \leq 5,00$

Damid 200 AL - Gr 2:  $1,50 \leq \varnothing \leq 5,00$

Other dimensions or grade upon request

## Standard

A400/630

## Shelf life:

6 years, under normal ambient conditions

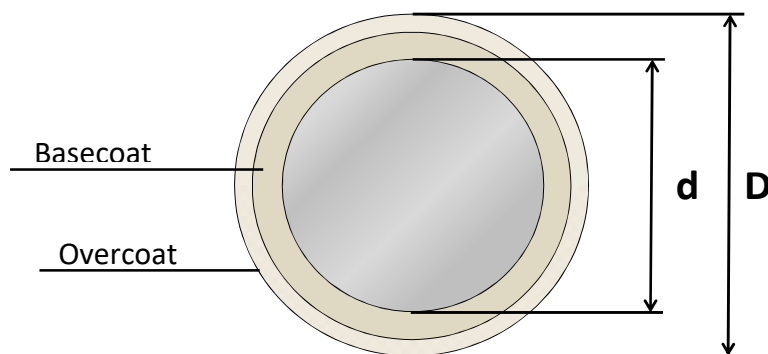

$D - d = \text{Increase}$

# DAMID 200 AL

Round enamelled conductor of aluminium, heat resistant, class 200

## Properties for DAMID 200 AL

Main characteristics	Test method	Property values	Test values for a Damid 200 AL sample (2,00 mm, Gr2)
<b><u>Thermal properties</u></b>			
Heat shock	IEC 60851 - 6.3	≥ 220°C	≥ 220°C
Cut-through	IEC 60851 - 6.4	≥ 320°C	OK at 340°C
Temperature index	IEC 60172	≥ 200°C <sup>1)</sup>	≥ 200°C <sup>1)</sup>
<b><u>Electrical properties</u></b>			
Conductivity	1/R	> 35,5 m/(Ωmm <sup>2</sup> )	> 35,5 m/(Ωmm <sup>2</sup> )
Breakdown voltage	IEC 60851 - 5.4	IEC 60317-0-3 <sup>2)</sup>	9,0
<b><u>Mechanical properties</u></b>			
Elongation	IEC 60851-3.3	IEC 60317-0-3 <sup>2)</sup>	25%
Flexibility	IEC 60851-3.5	Mandrel wind. <sup>3)</sup>	3 x Ø
		Stretching <sup>4)</sup>	min 15 %
Adherence	IEC 60851-3.5	Jerktest <sup>5)</sup>	No loss of adhesion
		Peeltest <sup>6)</sup>	min. 110 <sup>7)</sup>

1. According to supplier certificate

2. Values depend on dimension

3. Up to and including 1,60 mm

4. Over 1,60 mm

5. Up to and including 1,00 mm

6. Over 1,00 mm (internal LWW standard)

7. Revolutions x nominal dimension

Values above are for information only. All values noted are typical and can vary between lots and dimensions.